

1

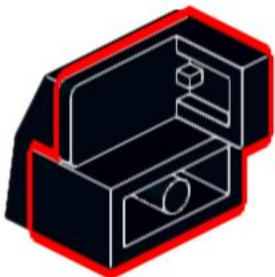

2

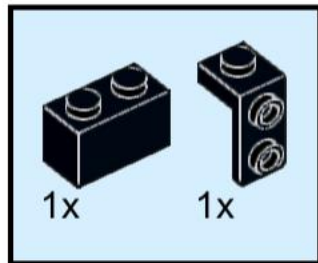

3

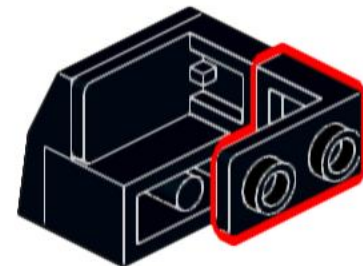
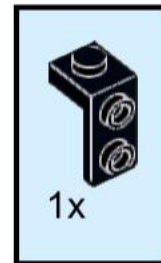

4

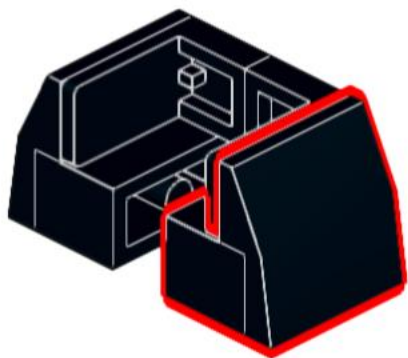
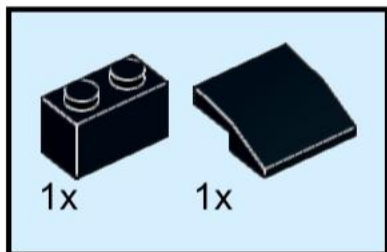

5

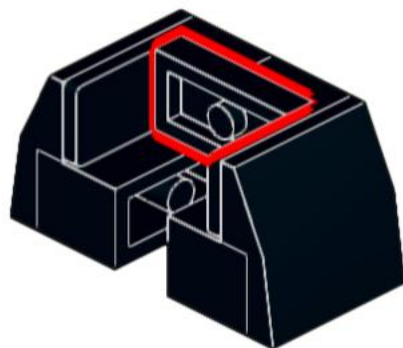
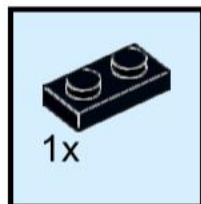

6

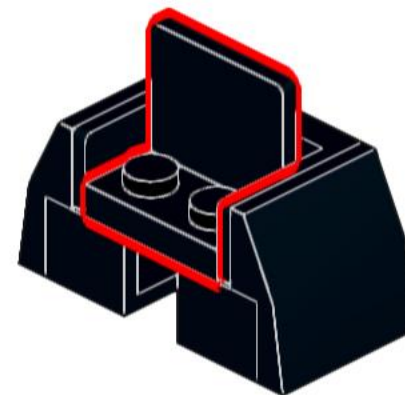
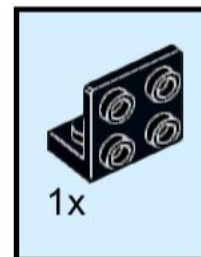

7

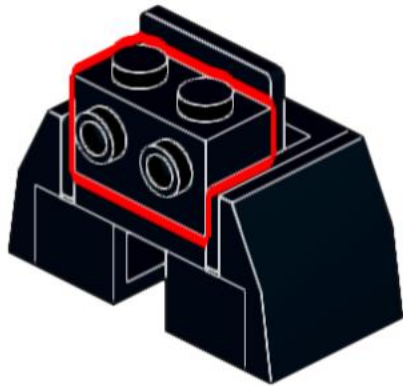
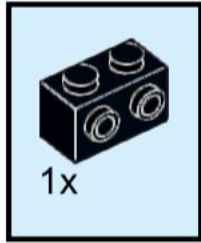

8

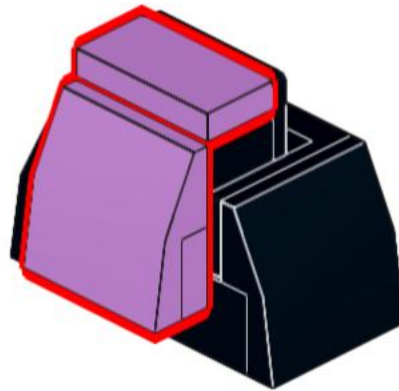
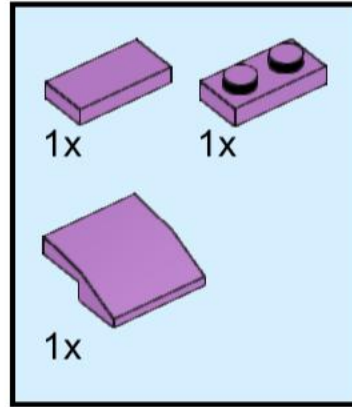

9

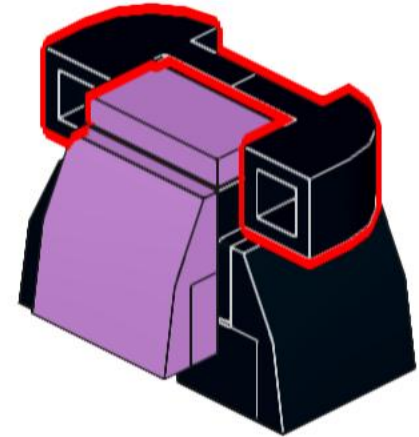
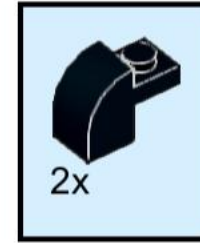

10

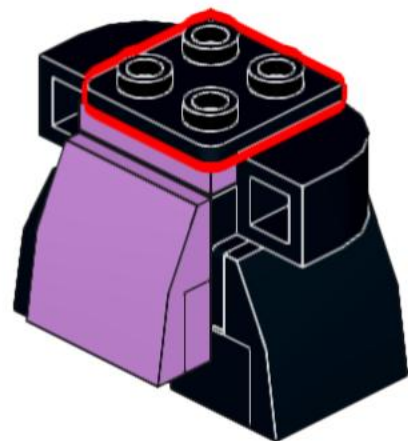
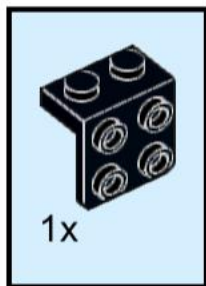

11

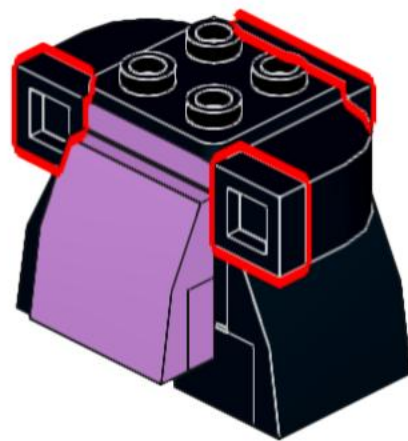
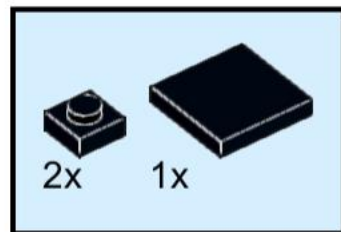

12

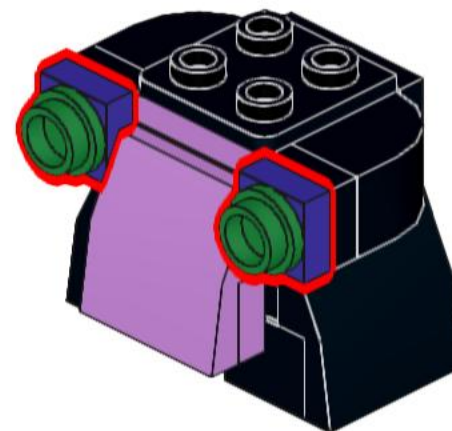
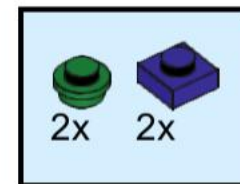

13

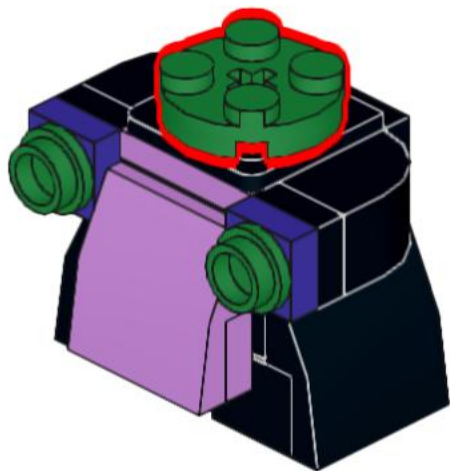
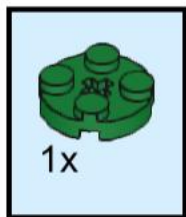

14

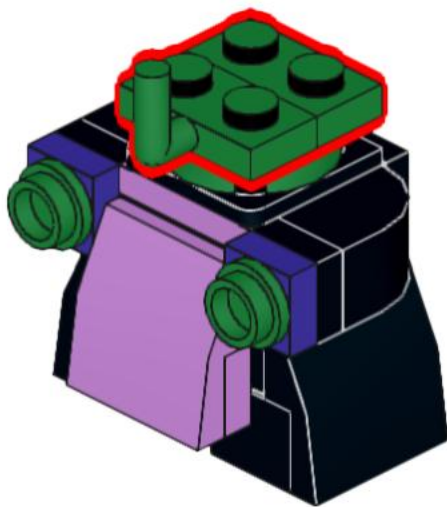
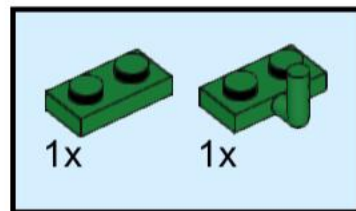

15

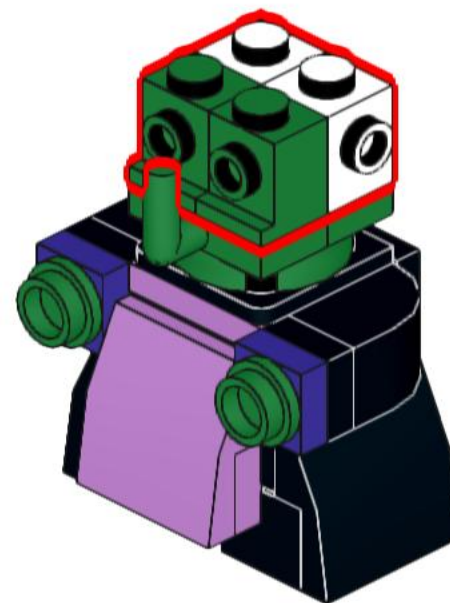
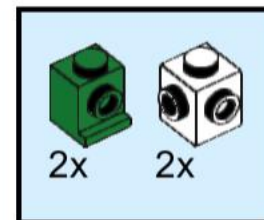

16

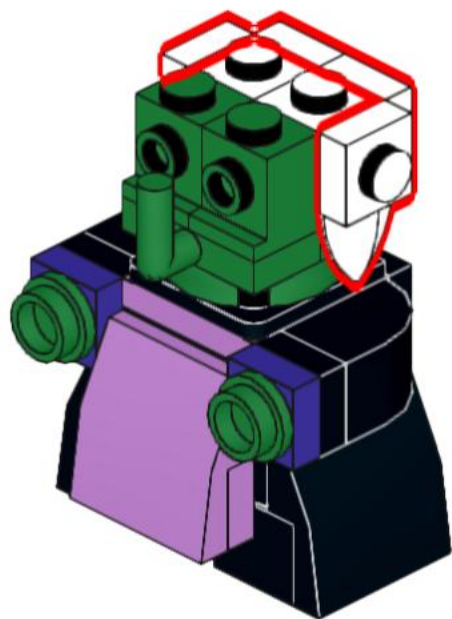
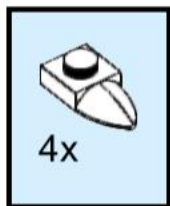

17

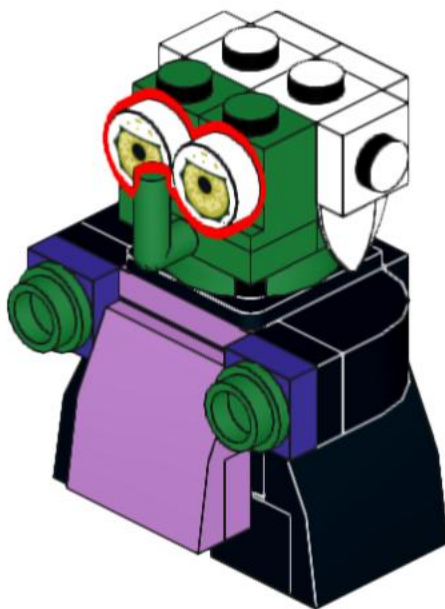
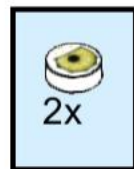

18

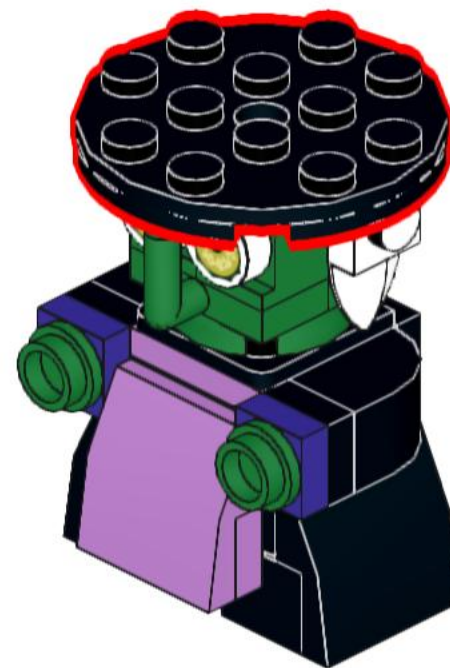
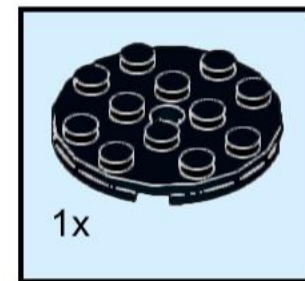

19

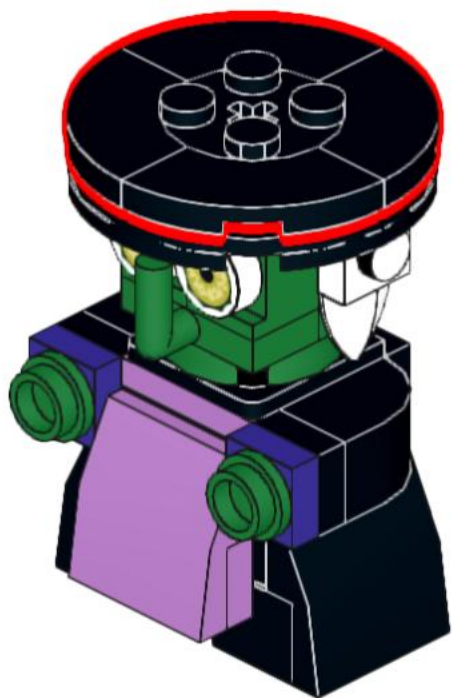
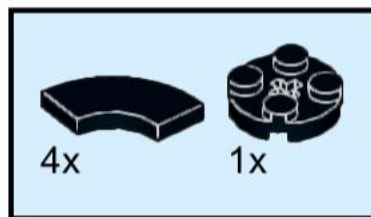

20

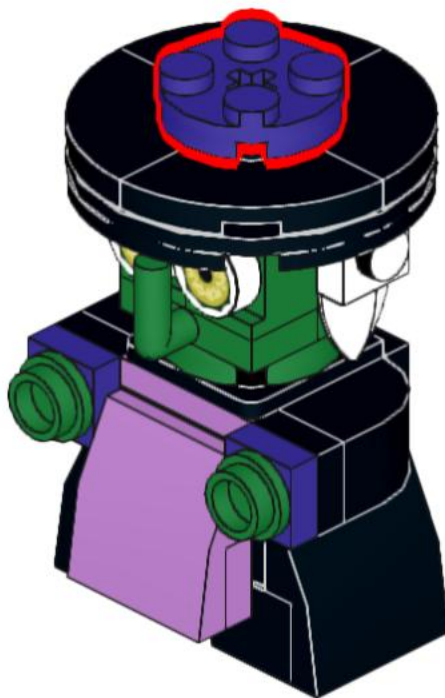
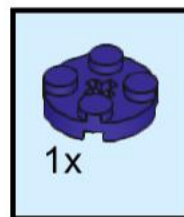

21

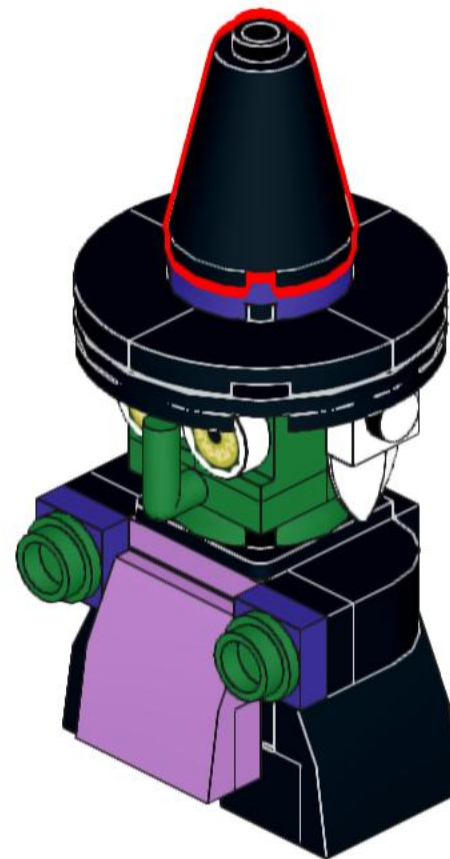

**LA P'TITE
BRIQUE**

The logo consists of the text 'LA P'TITE' on the top line and 'BRIQUE' on the bottom line, both in a bold, dark blue, sans-serif font. The letter 'Q' in 'BRIQUE' is replaced by a dark blue silhouette of a brick cart. The cart is filled with a pile of colorful bricks in shades of purple, green, yellow, and red. Three white wheels with black dots are visible at the bottom of the cart.

**LA P'TITE
BRIQUE**

The logo features the text 'LA P'TITE' on the top line and 'BRIQUE' on the bottom line, both in a bold, red, sans-serif font. The entire text is enclosed within a thick yellow rectangular border.